

Data Sheet

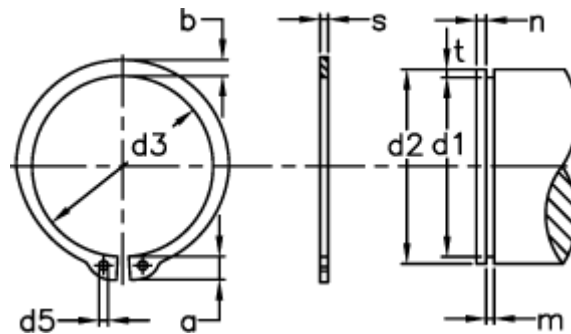

Article number: 0109049
 Description: Retaining ring AS 32x2.0
 Spring steel
 Note: Fitted with ZGA pliers

Measures



a max	= 6.5	Description	= AS 32	s	= 2.00
AN mm ²	= 77.8	FN kN	= 12.90	t	= 0.85
B	= 1.78	FRg kN	= 13.6	tol	= -0.21
b	= 4.1	FR kN	= 57.0	tol	= -0.07
d1	= 30.3	g	= 1.5	tol	= +0,25 -0,50
d2	= 32	m min	= 2.15	Tong	= ZGA-2
d3	= 29.6	n abl x 1000	= 20	Weight kg/1000	= 5.40
d5 min	= 2.5	Nominal drive	= 2.5		